

Montageanleitung RJ45-Buchse Installation instruction RJ45-Jack

1 – RJ45-Buchse ohne 90°-Adapter

RJ45-Jack without 90° adapter

Montageanleitung Seite 2&3
Mounting instruction page 2&3

Demontageanleitung Seite 4
Disassembling instruction page 4



2 – RJ45-Buchse mit 90°-Adapter

RJ45-Jack with 90° adapter

Montageanleitung Seite 5&6
Mounting instruction page 5&6

Demontageanleitung Seite 7
Disassembling instruction page 7



90°-Adapter (Satz mit 20 Stück)
Optional erhältlich
90° adapter (set with 20 pcs.)
Available accessory

1 – Kabelmantel entfernen

Remove cable sheath

Außenmantel ca. 30 mm abisolieren. Schirmgeflecht nach hinten stülpen. Schirmbeidraht um Kabel wickeln. Optional: Kupferband anbringen. Überstand abschneiden

Dismantle the cable sheath approx. 30 mm. Wrap the drain wire around the cable. Optional: Put the copper tape around the cable. Cut off the wire mesh shield

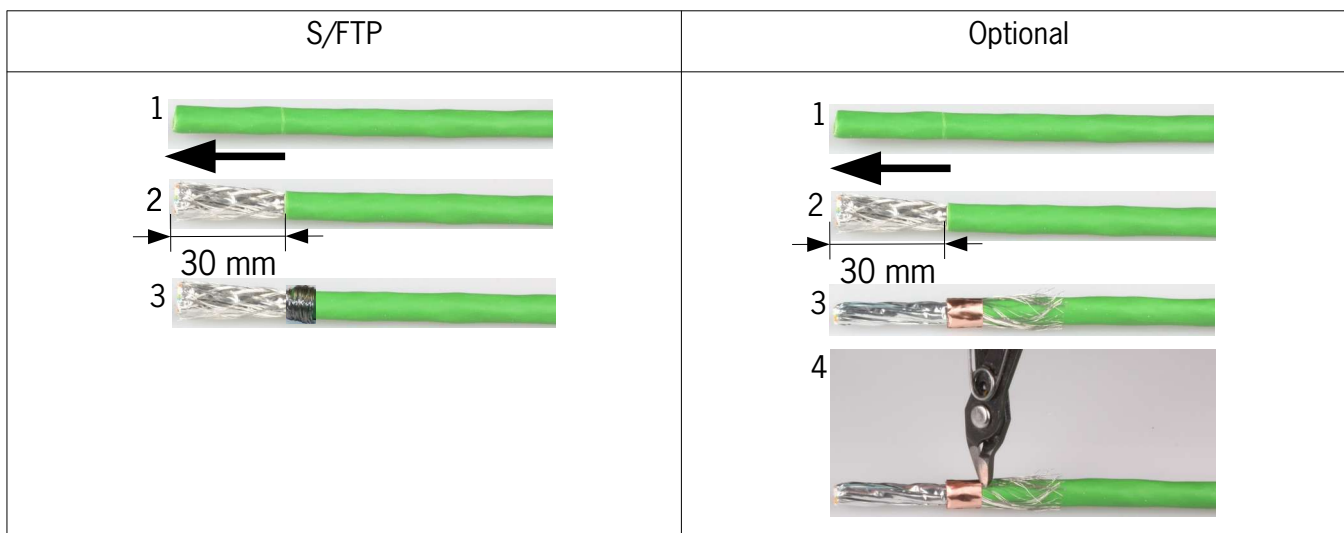

2 – Adernvorbereitung

Wire arrangement

Adernpaare nach gewünschtem Farbcode vorsortieren und sauber auszukreuzen.

Arrange the wires according to the wanted colour code und gouge accurately.

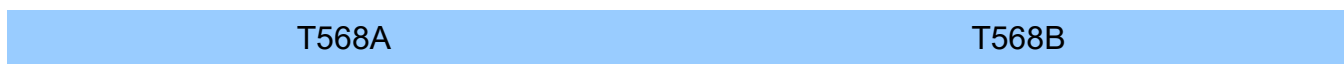

Seite 1 / side 1

Seite 2 / side 2

Seite 1 / side 1

Seite 2 / side 2

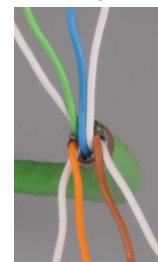
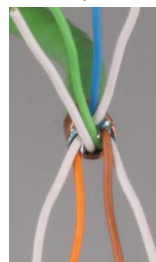
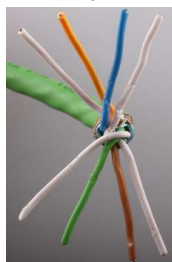

Blaues Paar nach oben
Grünes Paar nach unten
Blue pair upward
Green pair downward

kein Auskreuzen
notwendig
no cross-bonding
necessary

Grünes Paar
nach oben ziehen
Green pair upward

Blaues Paar
nach oben ziehen
Blue pair upward

Paarschirmung auf 2 mm kürzen. Adern 1/2 und 7/8 schräg abschneiden.

Shorten the pair foils to 2 mm. Trim the wire pairs 1/2 and 7/8 bevel.

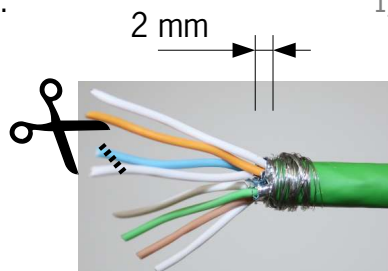

3 – Kabel einstecken

Adern in unteren Teil des Adernsortierers einführen und Kabel bis Anschlag schieben. Kabel mit Kabelbinder fixieren und bündig abschneiden.



Insert cable

Feed the wires in the bottom part of the cable sorter and push the cable to stop. Fix the cable by using a cable strap and cut it flush.

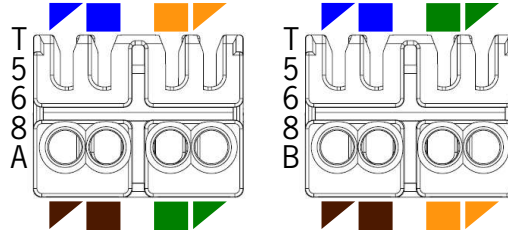

4 – Adern einlegen

Adern in oberen Teil des Adernsortierers entsprechend dem Farbcode eindrücken. Adern dürfen dabei nicht oben überstehen.



gut / good

Place wires

Push in the wires according to the colour code in the cable sorter. Make sure, that the wires do not overlap the cable sorter

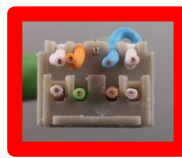

schlecht / bad

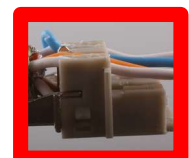

5 – Adern abschneiden

Adern bündig am Adernsortierer abschneiden.

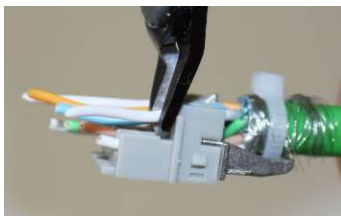

Trim wires

Trim the wires flush with the cable sorter.

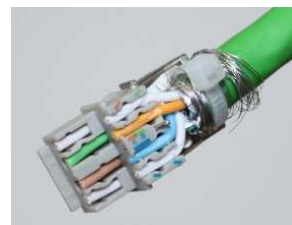

6 – Endmontage

Deckel auf Buchse setzen und mittig verpressen.



Deckel nicht verkanten!
Don't tilt the cover!

Final assembly

Put the cover on the jack and press the parts together in the middle.



Demontageanleitung RJ45-Buchse Disassembling instruction RJ45-Jack

1 – Deckelrastung lösen

Mit Schlitz-Schraubendreher Deckelrastung durch vorsichtiges Hebeln lösen.

Deckel gegen Wiedereinrasten sichern.

Gegenüberliegende Seite auf gleiche Art lösen.

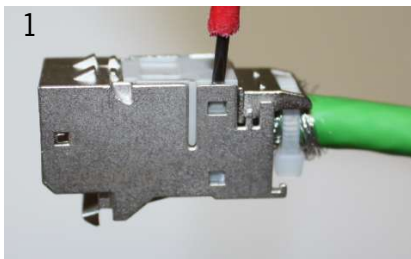

Open cover arrestor

Use a slot screwdriver to lever up the cover arrestor carefully.

Secure the cover against clicking back into place.

Repeat the step on the other side.



2 – Deckel abnehmen

Deckel vorsichtig mit einem dünnen Schraubendreher vollständig von Buchse lösen. Schraubendreherposition im Bild beachten.

Remove cover

Remove the cover with a thin screwdriver carefully. Look at the picture for positioning of the screwdriver.

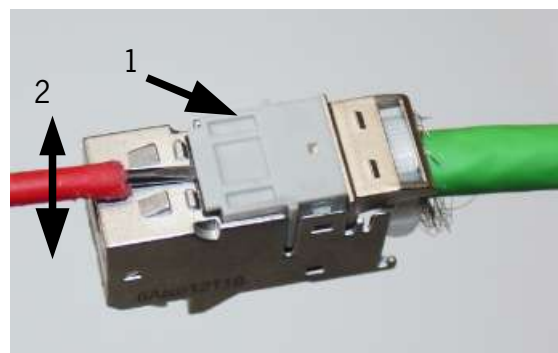

Montageanleitung RJ45-Buchse mit 90°-Adapter Installation instruction RJ45-Jack with 90° adapter

1 – Kabelmantel entfernen

Remove cable sheath

Außenmantel ca. 30 mm abisolieren. Schirmgeflecht nach hinten stülpen. Schirmbeidraht um Kabel wickeln. Optional: Kupferband anbringen. Überstand abschneiden

Dismantle the cable sheath approx. 30 mm. Wrap the drain wire around the cable. Optional: Put the copper tape around the cable. Cut off the wire mesh shield

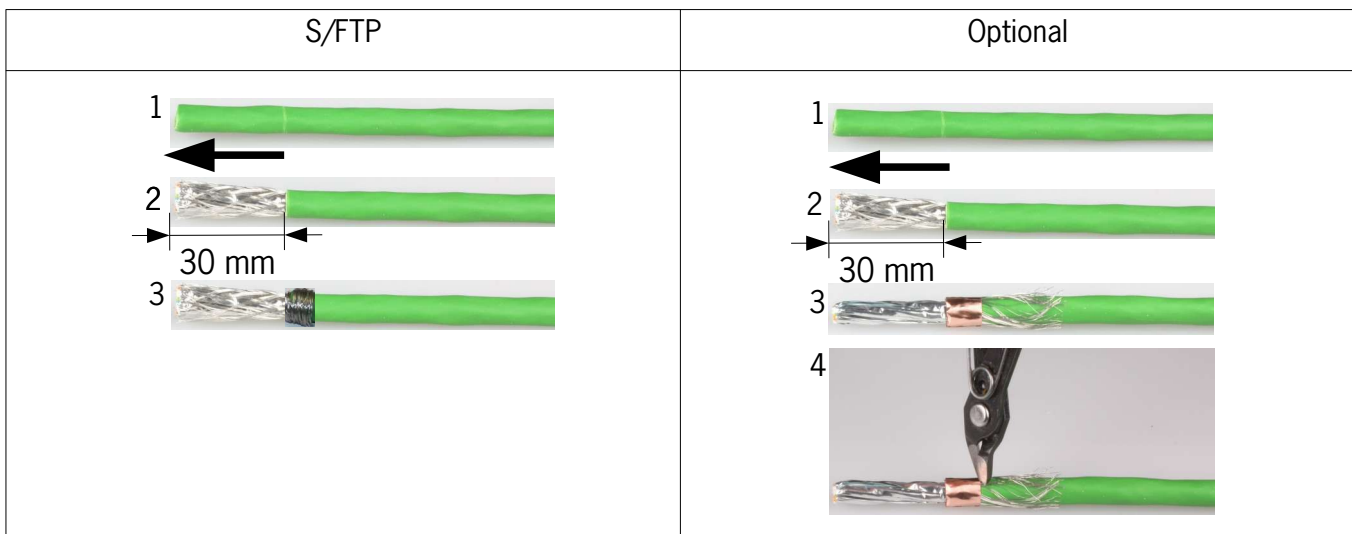

2 – Adernvorbereitung

Wire arrangement

Adernpaare nach gewünschtem Farbcode vorsortieren und sauber auszukreuzen.

Arrange the wires according to the wanted colour code und gouge accurately.

T568A		T568B	
-------	--	-------	--

Seite 1 / side 1

Seite 2 / side 2

Seite 1 / side 1

Seite 2 / side 2

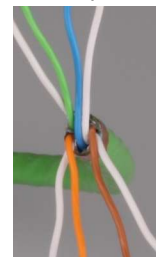
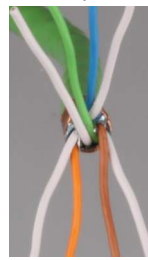
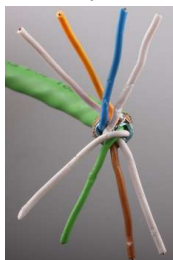

Blaues Paar nach oben
Grünes Paar nach unten
Blue pair upward
Green pair downward

kein Auskreuzen
notwendig
no cross-bonding
necessary

Grünes Paar
nach oben ziehen
Green pair upward

Blaues Paar
nach oben ziehen
Blue pair upward

Paarschirmung auf 8 mm kürzen. Adern 1/2 und 7/8 schräg abschneiden.

Shorten the pair foils to 8 mm. Trim the wire pairs 1/2 and 7/8 bevel.

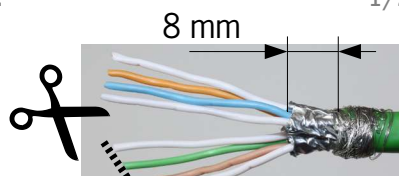

3 – Kabel einstecken

Kabelbinder von Deckel entfernen. Adern in unteren Teil des Adernsortierers einführen und Kabel bis Anschlag schieben. Adern in oberen Teil des Adern-Sortierers entsprechend dem Farbcode eindrücken.

Insert cable

Remove cable strap from cover. Feed the wires in the bottom part of the cable sorter and push the cable to stop. Push in the wires according to the colour code in the upper part of cable sorter.

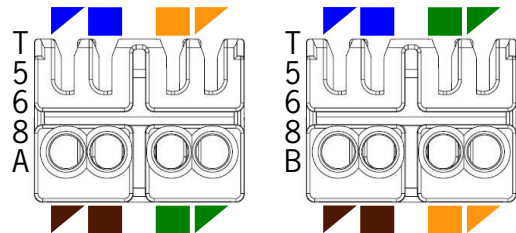
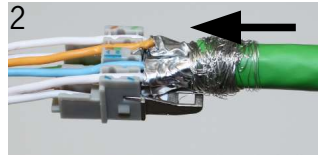
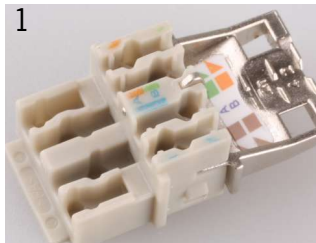

3a – Adern einlegen

Siehe Seite 3 Punkt 4

Place wires

See page 3 point 4

4 – 90°-Adapter anbringen

Kabel in Montageposition bringen. 90°-Adapter aufschieben und einrasten. (KLICK)

Fix 90° adapter

Move cable into mounting position. Pull on the 90° adapter and let it snap-in. (CLICK)

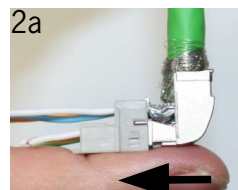

5 – Adern abschneiden

Kabel mit Kabelbinder fixieren und diesen bündig abschneiden. Auf Position des Kabelbinder-schlusses achten. Adern bündig am Adernsortierer abschneiden.

Trim wires

Fix the cable by using a cable strap and cut it flush. Take care of the cable strap's lock position. Trim the wires flush with the cable sorter.

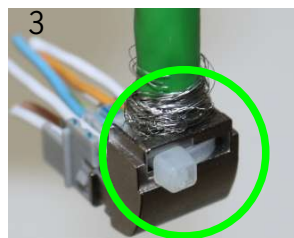
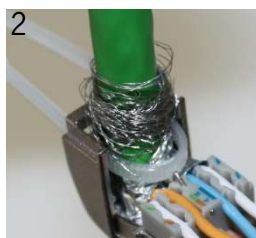
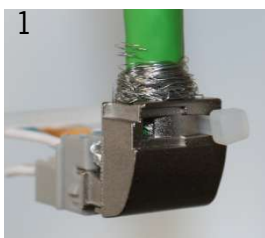

6 – Endmontage

Siehe Seite 3 Punkt 6

Final assembly

See page 3 point 6

Demontageanleitung RJ45-Buchse mit 90°-Adapter Disassembling instruction RJ45-Jack with 90° adapter

1 – Deckel Rastung lösen

Siehe Seite 4 Punkt 1

Open cover arrestor

See page 4 point 1

2 – Deckel abnehmen

Siehe Seite 4 Punkt 2

Remove cover

See page 4 point 2

3 – 90°-Adapter entriegeln

Schlitz-Schraubendreher unter Verrastung einführen und diese vorsichtig anheben.

Release 90° adapter

Put a slot screwdriver under the latch and release it by carefully lifting.

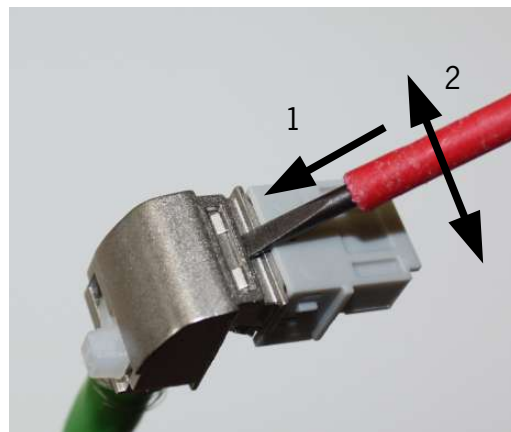

Montageanleitung RJ45-Buchse Erdung Installation instruction RJ45-Jack grounding

Erdung nach DIN 46342-1

Kabelschuh (2,8 mm x 0,5 mm) an Erdkabel anbringen.

Erdkabel auf Zunge am Raster aufschieben.

Grounding according to DIN 46342-1

Assembly cable shoe (2,8 mm x 0,5 mm) at the cable.

Push cable shoe on the tongue of the clip.

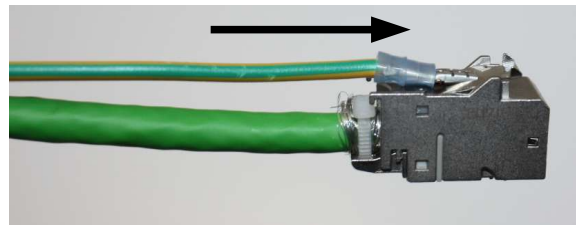

Anwendungen Applications

Anschluss / Connection		Anwendung / Application					
Farbcode / Colour code		PROFINET	RJ45-Pin	Ethernet 10BT Fast Ethernet 100BT	1 Gigabit/ 10 Gigabit Ethernet	Token Ring ISDN/S ₀	Upo/ TEL
A	B						
W - G	W - O	YE	1	•	•		
G	O	OG	2	•	•		
W - O	W - G	WH	3	•	•	•	
BL	BL	-	4		•	•	•
W - BL	W - BL	-	5		•	•	•
O	G	BU	6	•	•	•	
W - BR	W - BR	-	7		•		
BR	BR	-	8		•		

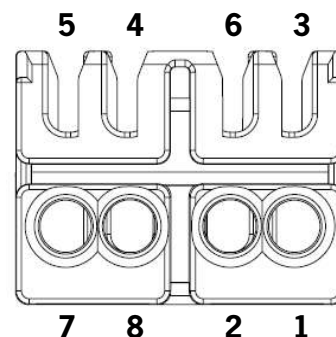

Druckfehler, Irrtümer und technische Änderungen vorbehalten